



Heat recovery
ventilation system
«Klimatronik 160 PRO»

DATA SHEET

Contents

1. Purpose and scope of the system	4
2. Basic features.....	6
3. Specifications.....	8
4. Advanced features	10
5. System operating principle.....	13
6. Overall dimensions	14
7. Safety requirements	15
8. Installation of the recuperator.....	16
9. Energization	26
10. Operation.....	28
11. Maintenance	29
12. Shipping and storage instruction.....	30
13. Disposal.....	31

1. Purpose and scope of the system

Heat recovery ventilation system Klimatronik 160 PRO is a solution that provides a comfortable indoor climate. Klimatronik recuperators are designed for continuous ventilation with simultaneous operation of air supply and exhaust without mixing air flows while preserving thermal energy in the room.

The device provides a continuous supply of fresh air and exhaust of waste air together with fine dust and other pollutants from the room. This principle of ventilation promotes better well-being of people, improves their performance ability and health.

The recuperator is efficient:

- at permanent ventilation with maintenance of the optimum air humidity and conditions that prevent mold growth and stuffiness;
- at saving heat and thus saving money during ventilation in the cold season and keeping the cold in the hot season;
- in crowded rooms* up to 60 m², ensuring continuous air renewal and maintaining the optimum level of carbon dioxide (CO₂) for better well-being and performance ability;
- at supplying clean air without pollutants, bacteria and volatile organic compounds (VOC) that are dangerous to health (smoke, odours, natural gas and carbon monoxide, formaldehydes, phenols, alcohols and other hazardous substances) for the permanent maintenance of more favorable conditions for normal human health.

* Prolonged stay of three or more people in a room up to 60 m² requires intensive ventilation for normal well-being.

Klimatronik 160 PRO recuperators are intended for use in most types of rooms:

- domestic premises: apartments, private houses;
- academic institutions;
- hotel rooms, hostels;
- working rooms, offices;
- storage rooms;
- sports facilities;
- basements and daylight basements;
- preschool facilities (kindergartens, hobby groups);
- healthcare institutions;
- hairdressing studios and beauty salons;
- entertainment establishments;
- food establishments.

2. Basic features

Basic functional features of Klimatronik recuperators are:

- permanent supply of fresh air into the room and exhaust of waste air outside;
- recovery of heat in winter and coolness in the warm season;
- equalization of pressure inside the room;
- normalization of humidity;
- equalization of temperature in the entire volume of the room;
- air monitoring and purification from volatile organic compounds (VOC);
- air monitoring and normalization of carbon dioxide (CO₂) level;
- indicators of outdoor and indoor temperatures, humidity and air quality.



3. Specifications

Parameter		Klimatronik 160 PRO
Recuperator type		Countercurrent: simultaneous air supply and exhaust without mixing air flows
Functionalities of the ventilation system		Heat recovery, cold recovery, air supply and exhaust, air exhaust only, air supply only
Diameter of the working module, mm		160
Required diameter of the installation hole		162
Installation wall thickness, mm		At least 410
Device installation type		Intrawall installation
Back grille (cover) installation method		From the side of the room
Recommended room area, m ²		Up to 60
Recuperator operation modes		Auto, Turbo, Manual, Quiet
Number of speeds in the "Manual" mode:		11
Air exchange volume, m ³ /h	Klimatronik 160 L	Air supply: 20-90. Air exhaust: 20-90
	Klimatronik 160 M	Air supply: 20-120. Air exhaust: 20-120
	Klimatronik 160 H	Air supply: 20-150. Air exhaust: 20-150
Power consumption (minimum-maximum)*, W/h	Motors (front + back)	4-18
	Inflow heating	0-100**
	Defrosting	0-40**
Heat exchanger material		Copper
Heat exchanger area, m ²		0.9
Heat recovery efficiency*, %	«Auto» mode	50-96
	«Turbo» mode	40
	«Manual» mode	40-96
	«Quiet» mode	60-96
Equipment and functions of the device		Automatic heating of supply air. Automatic condensate heating (defrosting). Information LED-display. Automatic electric shutter valve. 2 three-phase EC-fans (with microcontroller). Automatic air quality control. Air flow balancing.
Noise level from the device at 3 m (minimum-maximum), dB	Klimatronik 160 L	12-30
	Klimatronik 160 M	12-34
	Klimatronik 160 H	12-42
Air purification filter class		G3 Carbon
Colour range of recuperators		White, black and white, black

Parameter		Klimatronik 160 PRO
Sensors and indicators		<ul style="list-style-type: none"> • Indoor carbon dioxide sensor (eCO₂) • Indoor volatile organic compounds sensor (TVOC) • 5 outdoor and indoor temperature sensors • Indoor humidity sensor • Light sensor • Fan speed level indicators • Mode indicator • Inflow heating indicator • Defrosting indicator • Wi-Fi connection indicator • Indoor CO₂ level indicator • Indoor humidity • Inflow temperature • Outdoor temperature • "Turbo" mode timer • Clock
System control		Remote control, mobile app (control via home Wi-Fi network) for Android and iOS
Features provided by the mobile app		<ul style="list-style-type: none"> • Flexible operation control • Setting of the weekly schedule of the «Quiet» mode • Separate speed control of supply and exhaust fans in «Manual» mode • Indications of defrosting and inflow heating • Heat recovery efficiency indicator • Indicators of outdoor and indoor temperatures, humidity and air quality (both current and in the form of graphs over several time periods) • Naming of devices depending on their locations, etc.
Maintenance		Remote technical support: if the recuperator is connected to a home Wi-Fi network, our service engineer can remotely connect to it via the Internet, configure it and monitor the status of its operation.
Recuperator weight, kg	Net	3
	Gross	4
Overall dimensions, mm	Unpacked (L x H x W)	530/220/200
	Packed (L x H x W)	605/240/220
Supply voltage, V/Hz		220-240/50-60
Moisture protection of fan motor		IP67
Service life		Up to 10 years
Warranty service period		12 months
Remote technical support period		24 months
Optimal system use conditions		Temperature: -20 °C to +40 °C
		Relative humidity: 20% to 100%

* Depends on the operation mode of the recuperator and environmental conditions.

** These functions only turn on automatically at low outside temperatures. Heating works in an economical, «pulse» mode: it brings the temperature of supply air to a comfortable one, then turns off.

4. Advanced features

Heating of supply air

Klimatronik recuperators are equipped with the function of automatic heating of supply air in the cold period of the year. Heating works in an economical, «pulse» mode bringing the temperature of supply air to a comfortable one, then turns off. For maximum comfort, the heating of supply air operates automatically in all recuperator modes.

Defrosting

The defrosting function operates automatically in all recuperator modes. Defrosting prevents icing in the heat exchanger and recuperator tail, thus enabling steady operation of the system even at significant sub-zero temperatures.

Air flow balancing

The «Auto» mode features an algorithm for balancing the supply and exhaust air flows. Different indoor conditions and weather factors can cause inward or outward drafts in the recuperator ducts. The device analyzes the direction and strength of air flows and automatically adjusts fan speeds to balance the draft, thus preventing heat loss during the cold period, which increases the efficiency of heat recovery.

Passive system mode

The situation when the Klimatronik ventilation system is switched off (is in the passive «Off» mode) creates a potential possibility of uncontrolled air flows through the recuperator channels due to the difference in pressure and temperature inside and outside the room. This can cause drafts and unwanted flow of cold air from outside or leakage of warm air from the room during the cold period. For this reason, the device is designed with a servo-operated electric shutter-valve, which automatically closes the channels in the recuperator when it is in the passive «Off» mode.

Remote technical support

The Klimatronik system allows remote service control and diagnostics of recuperators via the Internet. This requires that the device is connected to the home Wi-Fi network. At the client's request, the service engineer can remotely access the device, configure it, monitor its status under routine maintenance and resolve user requests.



5. System operating principle

The Klimatronik heat recovery system uses a countercurrent heat exchanger, which ensures simultaneous air supply and exhaust without mixing air flows. The heat recovery process is due to an efficient copper heat exchanger, which transfers heat energy between air flows. In addition, copper is a natural antiseptic.

Thus, in the cold season, warm waste air is removed from the room by the exhaust flow, while transferring its heat to the counter flow of fresh air. In the warm season, the system operates similarly, but to keep the indoor air cool. The device is designed for round-the-clock functioning.

As a result, the Klimatronik system provides continuous automatic air renewal in the rooms with minimum heat loss. The recuperator heat exchanger is able to recover up to 96% of heat energy, depending on the use conditions.

6. Overall dimensions of the device

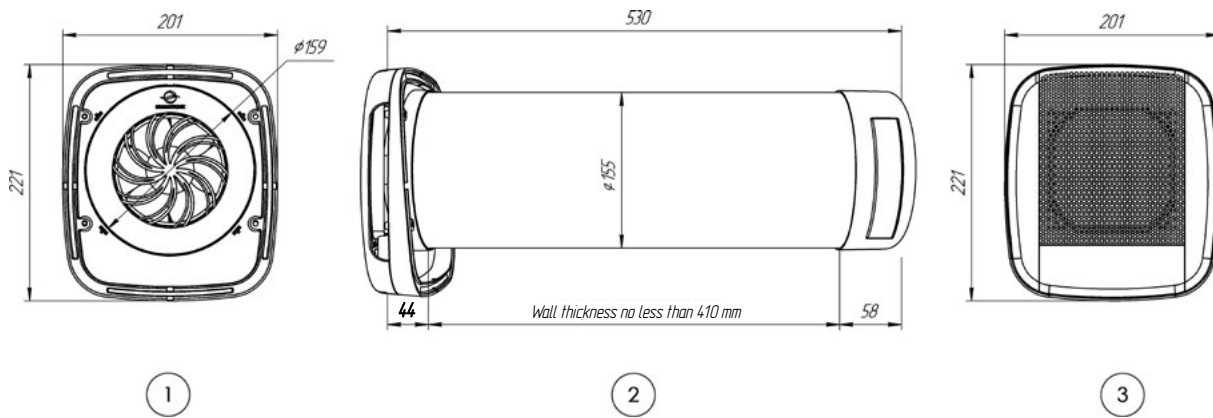

- 1 – Outdoor air intake
- 2 – Recuperator monoblock (side view without seals)
- 3 – Indoor air intake

7. Safety requirements

Installation and wiring works during the device connection shall be performed by an appropriately skilled trained professional. In case of failure to observe the installation regulations, the manufacturer bears no responsibility for the device operation.

ATTENTION!

All the installation and wiring works during the device connection (maintenance) shall only be performed on a de-energized device. Do not operate the ventilation system when there is a risk of foreign objects entering the flow section of the housing, which could jam or damage the impeller blades of either of the two fans. Do not operate the ventilation system in the rooms, in which the air contains corrosive substances and does not meet the operating temperature profile.

8. Installation of the recuperator

The ventilation system Klimatronik 160 PRO is a complete assembled monoblock, ready for designated use. The length of the Klimatronik ventilation system shall correspond to the thickness of the wall into which it is being installed. The correct length of the device in relation to the conditions of the room shall be agreed in advance and calculated with the manufacturer's representative.

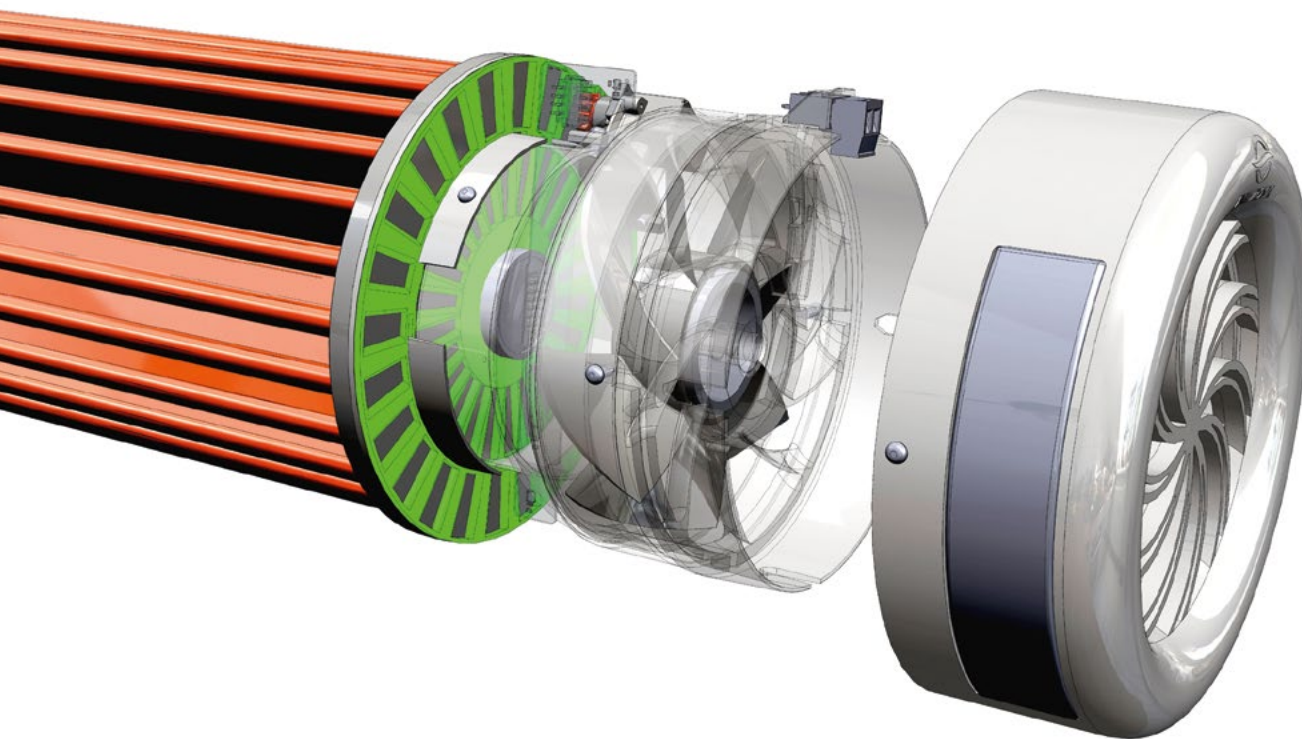

Recuperator installation procedure

Guidance on drilling the hole in the wall

1. Installation shall be carried out in such a way that the distance from the ceiling to the top of the face part of the recuperator is at least 150 mm.
2. The mounting hole for the recuperator shall be 162 mm in diameter. Drilling is carried out using a diamond crown with the appropriate diameter of the drill bit.



Bit with diameter of 162 mm

3. The hole shall be drilled at an angle of 4 degrees down to the outdoor side.



4. The installation works require a special vacuum cleaning drill or a drilling setup that facilitates wet hole drilling.



Installing the device into the mounting hole

1. Unpack the recuperator. Take the inner part of the recuperator out of the tube by gently pulling on the face part of the device.



2. Install the outer tube of the recuperator with foil foam and the back cover into the hole drilled in the wall. The upper part of the recuperator tube must always protrude from the wall by 8-10 mm on the indoor side, while the lower part of the tube may protrude by 13-15 mm, since the hole has been drilled at an angle of 4 degrees.

When installing the tube, note that the drain hole of the back cover shall be at the bottom. This is required for correct condensate drainage.

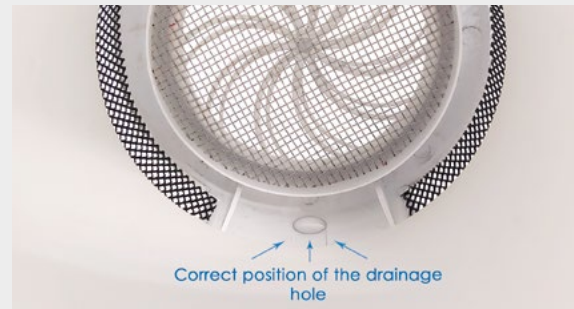
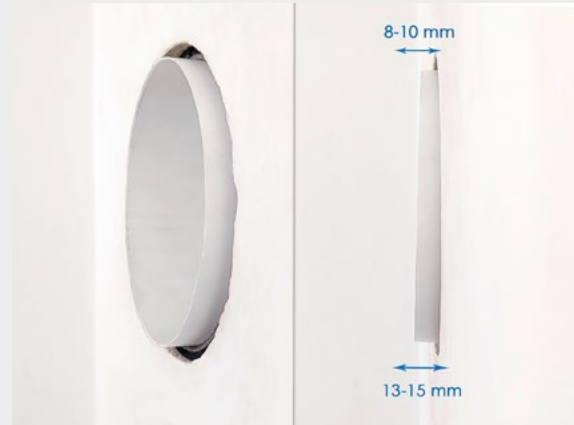

The back cover of the device shall protrude from the hole in the wall by at least 40-45 mm on the outdoor side for the possibility of condensate drainage and proper air intake.

3. Take the main part of the recuperator and check that the power cable with the 220 V power connector is properly secured at the joint.

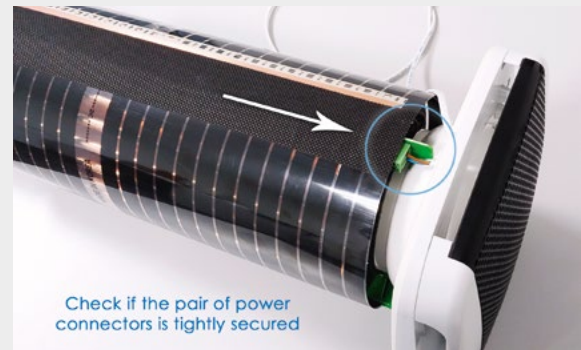

For reliable connection, secure the power cable with some allowance around the power connector.



For better fastening, it is advisable to insert the power cable into the special lugs in the base of the face side of the device.

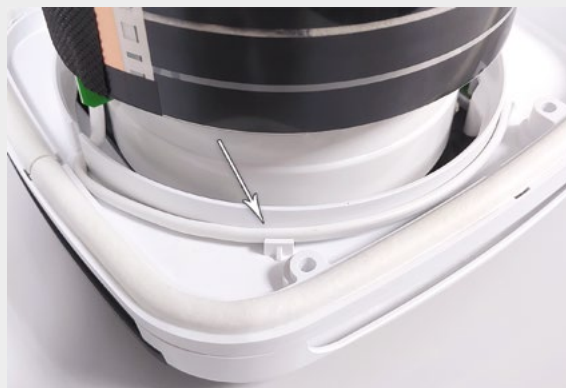

4. If necessary, make a neat cutout for the power cord in the base of the face part of the device housing. For that purpose, there are notch holes provided on four sides at the customer's option or at the discretion of installers.



5. Now carefully install the main part of the recuperator into the tube. The tight fit of the face part of the device to the wall means its correct installation.



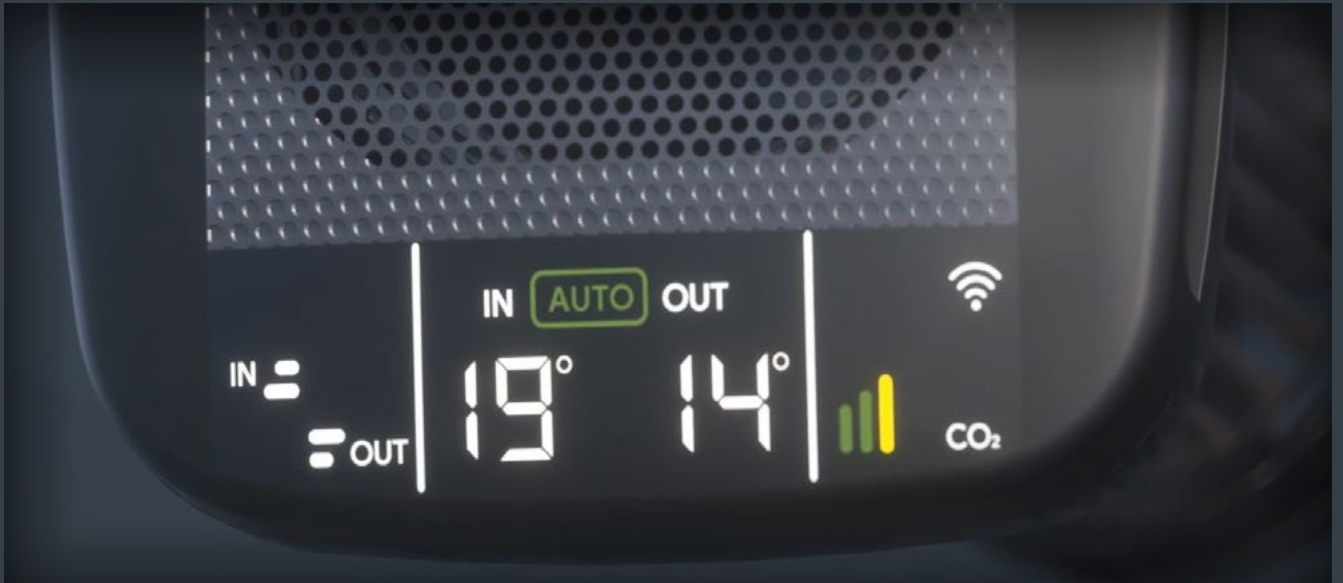

9. Device energization

The ventilation system shall be connected to a 230 V / 110 V mains. The connection is made using the power cable supplied as standard. If the device is wired using a user-provided power cable of other length, the cable gauge shall be 0.5-0.75 mm².

Initial start-up

Connect the recuperator to the electric mains. Once the system is energized:

- start the device using the remote control («ON/OFF» button);
- wait about 40 seconds, until the device automatically performs initial measurements of indoor and outdoor environment temperatures;
- check operation of the device fans in different modes using the remote control;
- check the correctness of the indications on the device display in different operating modes.

During normal operation of the device, there should be no extraneous noise during the operation of the fans, as well as no knocking or noise inside the structure.

In «Turbo» mode, check the supply and exhaust for adequate airflow by pressing the «Fresh» button on the remote control.

To do this, you can put your hand or a piece of paper to the supply and exhaust ducts alternately.

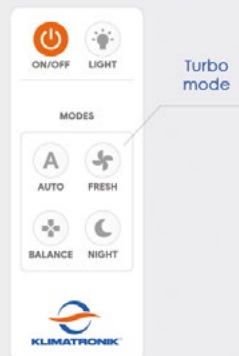

10. Operation

During operation of the device, regularly check the following:

- performance of the fans;
- correctness of graphic symbols of indication on the display;
- filter contamination.

The device must be disconnected from the mains if:

- there is high level of noise and vibration;
- components of the housing are damaged;
- insulation of the electric wire is damaged;
- outdoor air temperature is below -25°C .

11. Maintenance

For correct, efficient and long-lived operation, the Klimatronik system requires specialized maintenance by a professional. The maintenance includes periodical preventive inspection of surfaces of fans and heat exchanger and their cleaning as necessary.

The recommended frequency of preventive inspection is 2-3 times a year. If a user disassembles the device and cleans its components on their own, the manufacturer bears no responsibility for further correct operation of the system.

Depending on the use conditions, it is allowed and recommended to clean the filter in the face part of the device approximately once a month. To clean the filter, use a vacuum cleaner or wash it with running water and then dry it up.

12. Shipping and storage instructions

When transporting and storing the device in individual packing boxes, keep them in a horizontal position.

The recuperator shall be stored in factory packaging under cover (or in a confined space), at relative air humidity not exceeding 70% and air temperature within $-20\text{ }^{\circ}\text{C}$ to $+40\text{ }^{\circ}\text{C}$.

13. Disposal

At the end of its service life, the device can be disposed of. To do this, the device shall be taken to a collection point for recycling if it is stipulated in the rules and regulations of your region. This will help to avoid negative consequences for the environment and promote the reuse of device components.

Please contact your local authority for recycling information.

In order to improve the product, the manufacturer reserves the right to change product specifications at any time without prior notice. To clarify the specifications, please visit the manufacturer's website klimatronik.com.ua

Less viruses
Less dust
More oxygen



KLIMATRONIK.COM.UA